

VERDERGEAR Gear pump VGS430, 24 V

Description

Verdergear Gear Pumps are perfectly suitable for demanding applications in fluid transfer for dangerous liquids or expensive chemicals. They produce a very constant pulsation free flow without leakage.

The magnetically driven gear pumps have no shaft seals and are 100% leak free. The pumps are perfect for dosing and metering applications and ensure a repeatable and accurate flow. This execution is equipped with a brushless 24VDC motor with integrated speed controller. Speed can be adjusted with an external control analog signal 0 – 10V. Because of its compact small design perfectly suitable for OEM applications.

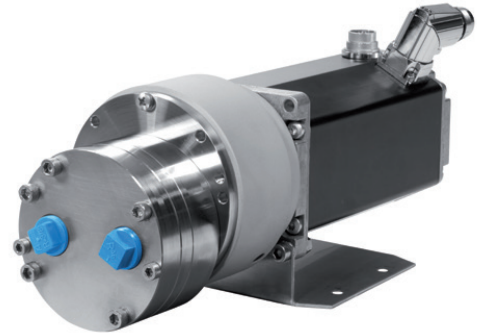

Advantages

- Ultra compact design for OEM applications
- Pulsation free flow
- Highly reliable
- High dosing accuracy
- Corrosion-resistant materials
- Self-priming
- Very user-friendly
- The target speed can be set using a 0...+10 V analog voltage input
- Wide range of flow control

Application areas

- Cooling systems
- Chemical industry
- Institutes Research & Development
- Food industry
- Pulp & Paper industry
- Textile industry
- Environmental technology
- Pharmaceuticals
- Pesticides

Technical data

Speed range	3.300 Rpm
Flow range	780 l/h
Max. differential pressure	10 bar
Max. system pressure	34 bar
Temperature range	-46 to +176 °C
Viscosity	1 - 2.000 mPas*
Connections	3/8 " NPT
Noise level	< 70 dB (A)
Material o-ring	PTFE (optional Viton)
Material gears	PEEK (optional PPS)
Material casing	Stainless steel 316L (optional Hastelloy, Titan)

* higher viscosities are possible on request

Options

- PROFIBUS cut surface
- PROFINET cut surface
- CANopen cut surface
- EtherCAT cut surface

VERDERGEAR Gear pump VGS430, 24 V

Flow curve

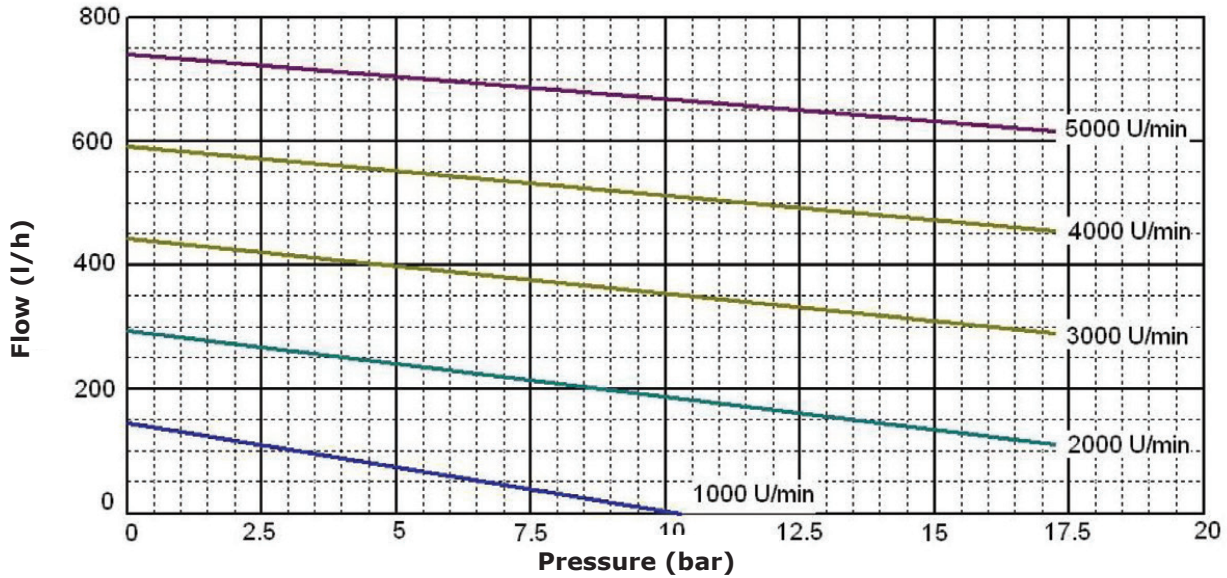

Performance curve based on: medium water, temperature 20°C, viscosity 1 cP, bypass closed

Drawing

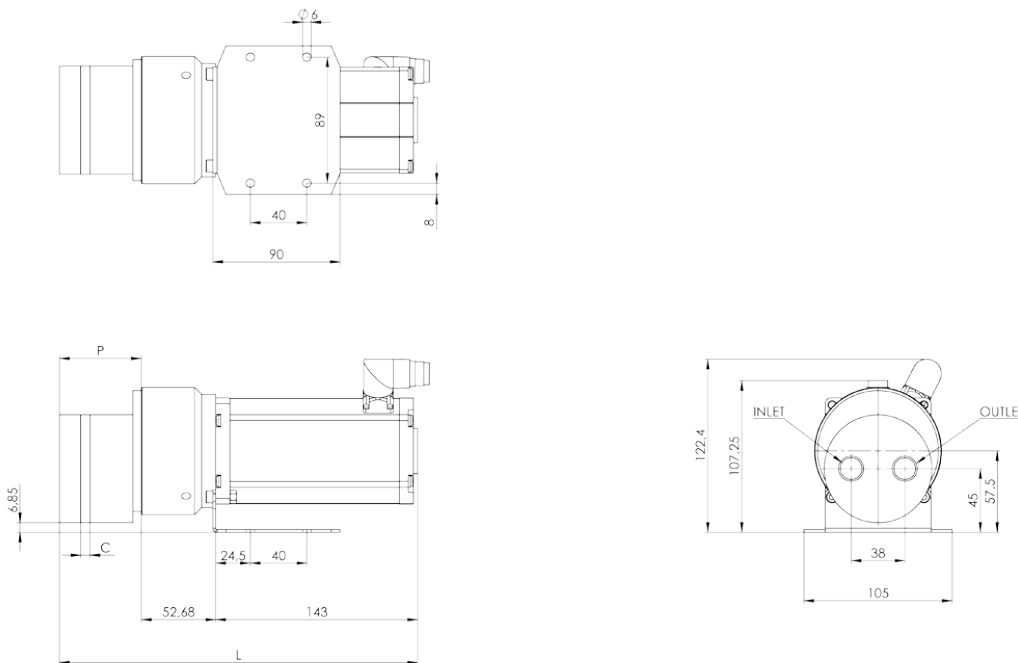

Modell	C	P	L	Inlet	Outlet
VGS430	7,9 mm	46 mm	241,68 mm	3/8" NPT	3/8" NPT