

VERDERGEAR Gear pump VGS260, 230 V OEM

Description

Verdergear Gear Pumps are perfectly suitable for demanding applications in fluid transfer for dangerous liquids or expensive chemicals. They produce a very constant pulsation free flow without leakage.

The magnetically driven gear pumps have no shaft seals and are 100% leak free. The pumps are perfect for dosing and metering applications and ensure a repeatable and accurate flow. This execution is equipped with a 230V single phase motor for fixed speed. Motor is suitable for frequency 50 and 60 Hz. capacitor is housed in the terminal box, therefore protection class IP55 is guaranteed. Drive is available for pump heads VGS015-380. Because of its compact small design perfectly suitable for OEM applications.



Advantages

- Complete dosing package
- Pulsation free flow
- Highly reliable
- High dosing accuracy
- Corrosion-resistant materials
- Self-priming
- Very user-friendly
- Wide range of flow control

Application areas

- Cooling systems
- Pharmaceuticals
- Chemical industry
- Institutes Research & Development
- Food industry
- Pulp & Paper industry
- Textile industry
- Environmental technology

Technical data

Speed range	2.650 Rpm
Max. flow range	240 l/h
Max. differential pressure	5 bar
Max. system pressure	34 bar
Temperature range	-46 to +176 °C
Viscosity	500 mPas
Connections	1/8 " NPT (optional 1/4 " NPT)
Noise level	< 70 dB (A)
Material o-ring	PTFE (optional Viton)
Material gears	PEEK (optional PPS)
Material casing	Stainless steel 316 (optional Hastelloy, Titan)

VERDERGEAR Gear pump VGS260, 230 V OEM

Flow curve

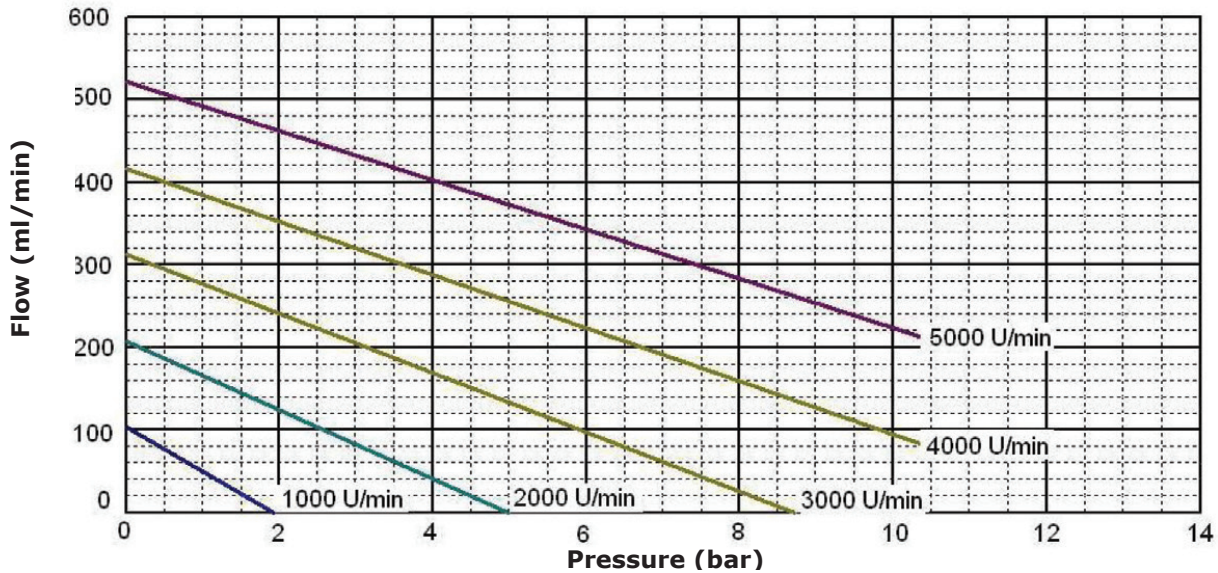

Performance curve based on: medium water, temperature 20°C, viscosity 1 cP, bypass closed

Drawing

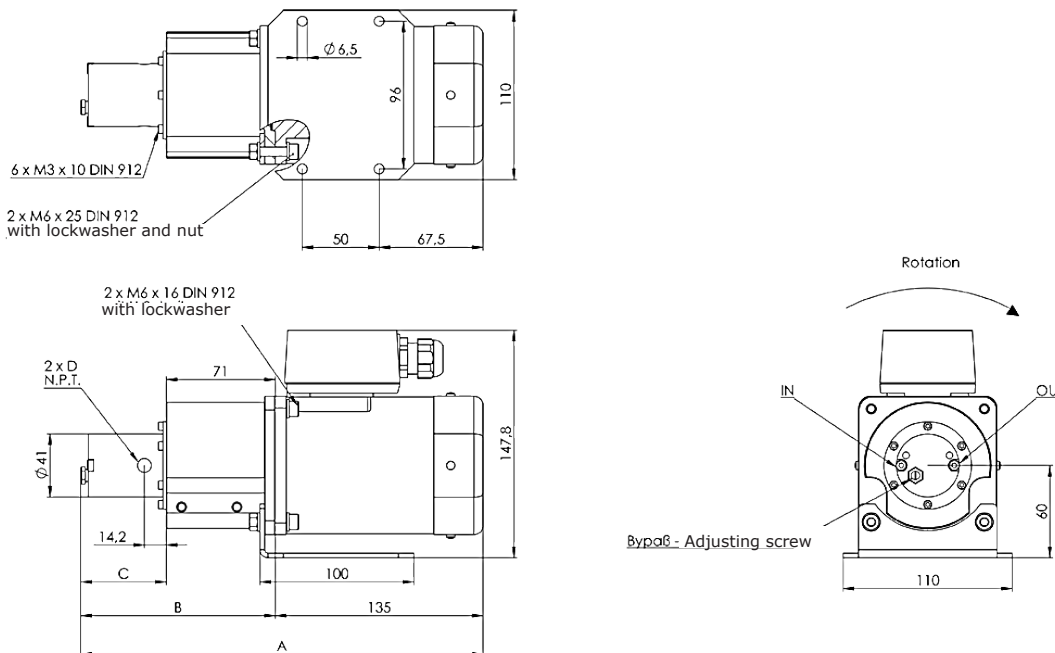

Modell	A	B	C	D
VGS260	278,7 mm	143,7 mm	72,7 mm	1/4 "