

VERDERFLEX[®]



Peristaltic Industrial Hose Pump

Spare Parts List

Dura 80

Version 01

Original instructions (en)





Version 01



Contents

1.	About.....	4
1.1	Pump layout – Exploded view.....	4
2.	Spare parts list	5
3.	Misc. for reference	9
4.	Accessories	10
5.	Hose options	11
6.	Lubricants.....	11
7.	Document history.....	12

1. About

This document contains a list of spares to help maintain and repair the Dura 80 peristaltic pump.

If in doubt, please contact your local Verder distributor and provide the pump serial number for genuine Verderflex® spares.

1.1 Pump layout – Exploded view

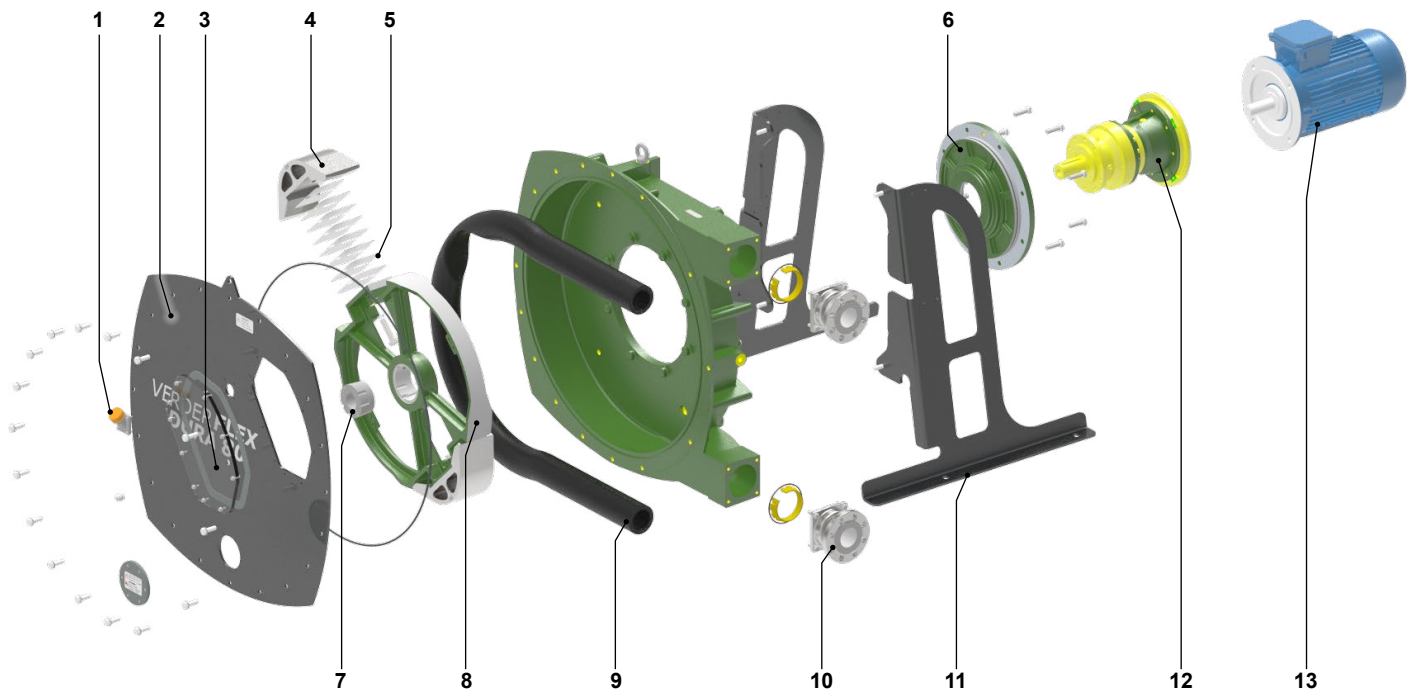
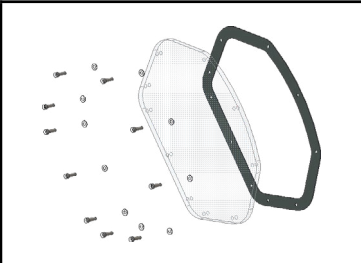
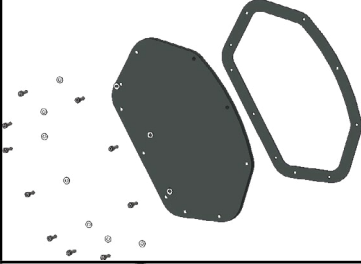
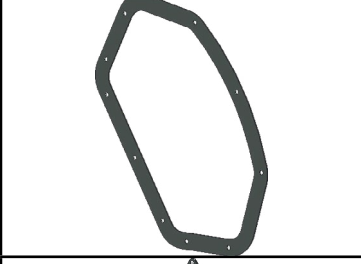

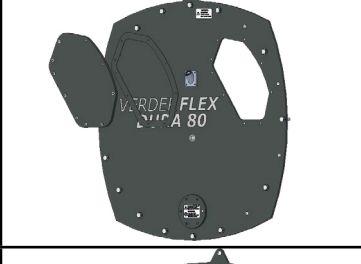



Figure 1. - Layout Dura 80 (Generic View)

- | | | | | | |
|---|-------------------------------|----|----------------------|----|----------|
| 1 | Filler port | 6 | Gearbox adaptor | 11 | Frame(s) |
| 2 | Front cover assembly | 7 | Taperlock bush | 12 | Gearbox |
| 3 | Front cover inspection window | 8 | Rotor assembly | 13 | Motor |
| 4 | Rotor shoe assembly | 9 | Hose | | |
| 5 | Shims pack | 10 | Port flange assembly | | |

2. Spare parts list

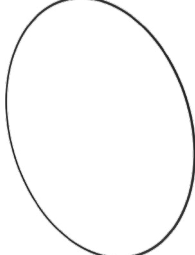
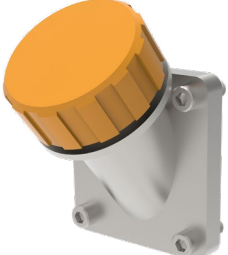
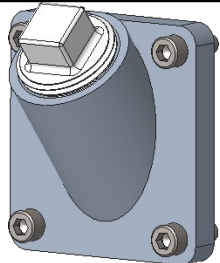
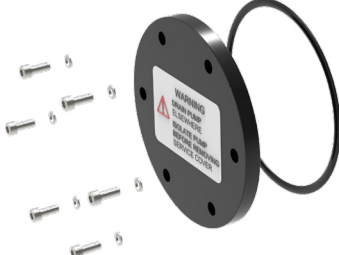
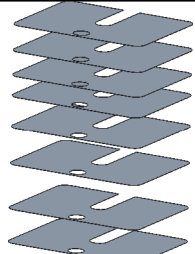

ITEM	DESCRIPTION	WEIGHT (KG)	PART No.	QTY	IMAGE
1.	Front Cover inspection window and gasket assembly	2.7	149.8001	1	
	ATEX front cover inspection window and gasket assembly*	16	149.8006	1	
	Inspection window gasket	0.07	149.8050	1	
2	Front cover assembly	94	149.8002	1	
	ATEX front cover assembly	107	149.8007	1	
	Front cover assembly Pos. 4	92	149.8005	1	

Spare Parts List (continued)

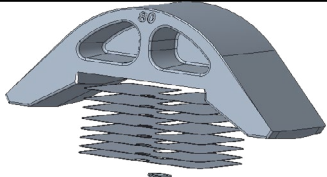
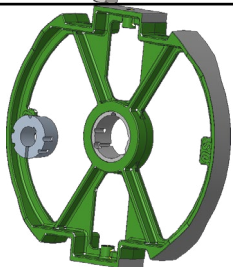
ITEM	DESCRIPTION	WEIGHT (KG)	PART No.	QTY	IMAGE
2	ATEX front cover assembly Pos. 4*	105	149.8008	1	
	Front cover O-ring	0.17	149.8051	1	
2.1	Filler port kit	0.25	149.6503	1	
	Filler port kit for pump fitted with hose burst and vent kit**	0.26	149.6541	1	
2.2	Service cover kit	3.1	149.6504	1	
3	Shims (pack of 18)	1.5	149.8013	1	

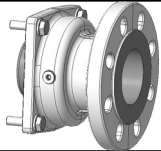
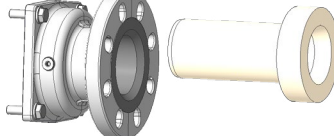
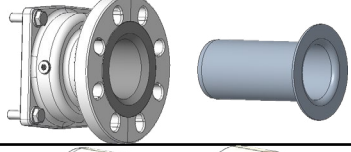

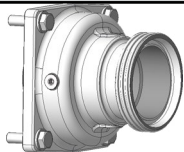
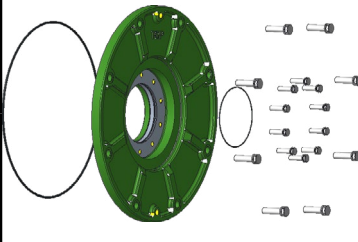
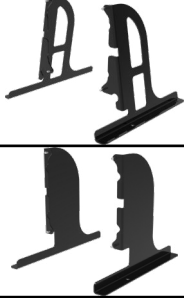



ITEM	DESCRIPTION	WEIGHT (Kg)	PART No.	QTY	IMAGE
4	Rotor shoe kit	20	149.8014	1	
5*	Rotor assembly	65	149.8012.60 (60 bore T-lock bush) 149.8012.75 (75 bore T-lock bush) 149.8012.80 (80 bore T-lock bush) 149.8012.90 (90 bore T-lock bush)	1	

ITEM	DESCRIPTION	WEIGHT (Kg)	PART No.	QTY	IMAGE	
6	Standard flange (supplied in pairs)	SS 1pc. Solid	18	149.8016	1	
		SS flange without insert	16.5	149.8017	1	
		SS flange complete with PP insert	17.5	149.8018	1	
		SS flange complete with PVDF insert	18.5	149.8019	1	
		SS flange complete with SS insert	18.5	149.8020	1	
6.1	Flange insert (supplied in pairs)	PP	1	149.8036	1	
		PVDF	2	149.8037	1	
		SS	2	149.8038	1	

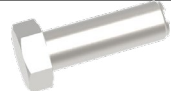

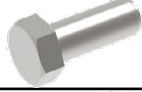
ITEM	DESCRIPTION		WEIGHT (Kg)	PART No.	QTY	IMAGE
6.2	Hygienic flange DIN11851 (supplied in pairs)		10	149.8039	1	
6.3	Hygienic flange DIN32676 (supplied in pairs)		10	149.8040	1	
6.4	Clamp ring (supplied as flange sealing kit)		0.2	149.8015	1	
7	Gearbox adaptor	305	50	149.8023	1	
		306	46	149.8024		
8	Mounting frame assembly	Standard	75	149.8021	1	
		VF80 footprint	67	149.8022		
9	Drain assembly		1.5	149.6532	1	

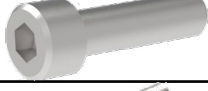
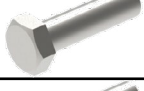
3. Misc. for reference

(Not supplied as individual spares by Verderflex)

ITEM	DESCRIPTION		IMAGE
10	Mounting frame fasteners	Screw hex head M16x50 - 10.9 BZP	
11	Rotor shoe fasteners	Screw hex head M20x90 - 10.9 BZP	
12	GMU adaptor & GMU screws (307)	Screw hex head set M16x60 - 10.9 BZP	
13	Front cover screws	Screw hex head set M16x50 - 10.9 BZP	
14	Port flange screws	Screw hex head set M12x45 - 10.9 BZP	
15	Inspection window screws	Screw socket head cap M8x30 - 8.8	
16	GMU screws (306)	Screw hex hd set M14x45 - 12.9 BZP	
17	GMU screws (305)	Screw hex hd set M12x45 - 10.9 BZP	
Washers	Mounting frame	M16 flat washer	
	Inspection window	M8 flat washer	
	Front cover	M16 flat washer	
	Rotor shoe	M20 disk lock washer	
	GMU adaptor	M16 flat washer	
	GMU	Washer spring Ø14, steel BZP (306) Washer spring Ø12, steel BZP (305)	

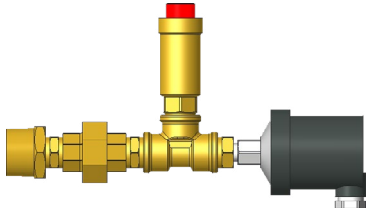
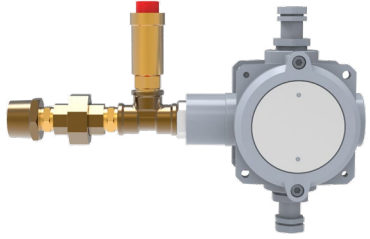
4. Accessories

DESCRIPTION	WEIGHT (Kg)	PART No.	QTY	IMAGE
High/low level sensor	0.6	149.8033	1	
Hose burst kit (non-ATEX)	2.3	129.0720	1	
Hose burst kit (ATEX)*	2.6	149.0730	1	
Revolution sensor	0.1	149.6549	1	

5. Hose options

DESCRIPTION	WEIGHT (KG)	PART No.	QTY	IMAGE
NR / white (singles)	18	129.0008	1	
NBR / yellow (singles)	18	129.0519	1	
NBRF / yellow + white (singles)	18	129.2028	1	
Hypalon® / green	18	129.2017	1	
EPDM / red	18	129.0017	1	

6. Lubricants

LUBRICANT	STANDARD QUANTITY SUPPLIED WITH PUMP IN LITRE (US GALLONS)	PART No.
Verderlube	35 litres (9.24 US gallons)	2 x 129.1420
VerderSil	35 litres (9.24 US gallons)	2 x 129.1382

7. Document history

Version	Description	Date	Approved
01	Initial release.	DEC '22	ISH

Trademarks

VERDERFLEX® is a registered trademark of Verder Liquids B.V. No permission is granted to use any Verder, trademarks or trade names included in this document without the prior written agreement of Verder Liquids B.V.

Tri-clamp® is a registered trademark of Alfa Laval Corporate AB.

Hypalon® is a registered trademark of RSCC Wire & Cable LLC.